

MR-180

Achieving Quality IPTV over DSL

Issue: 1
Issue Date: March 2012

Issue History

| Issue Number | Issue Date | Issue Editors | Changes |
|---------------------|-------------------|--|----------------|
| 1 | March 2012 | Peter Silverman, ASSIA Inc. Michael Hanrahan, Huawei Technologies | Original |

Comments or questions about this Broadband Forum Marketing Report should be directed to info@broadband-forum.org.

| | | |
|---|-------------------------------------|---|
| Editors | Peter Silverman Michael Hanrahan | ASSIA Inc. Huawei Technologies |
| Operations&Network Management WG Chair | Peter Adams | Adtran |
| Vice Chair | Moti Morgenstern | ECI |
| Marketing Committee Chair | Yue Chen | Juniper Networks |
| Vice-Chair | Sultan Dawood | Cisco Systems |
| White Papers Chairs | Sarah Banks Vanessa Nacamura | Cisco Systems Nokia Siemens Networks |
| Chief Editor | Michael Hanrahan | Huawei Technologies |

Table of Contents

| | |
|--|-----------|
| 1 EXECUTIVE SUMMARY | 6 |
| 2 INTRODUCTION..... | 6 |
| 3 QUALITY OF EXPERIENCE AND QUALITY OF SERVICE CHALLENGES FACING IPTV OVER DSL..... | 7 |
| 3.1 BANDWIDTH AND THE VIEWER EXPERIENCE..... | 8 |
| 4 MEETING THE REQUIREMENT OF IPTV OVER DSL..... | 9 |
| 4.1 DSL QUALITY MANAGEMENT (DQM) | 10 |
| 4.1.1 <i>Dynamic Spectrum Management (DSM)</i> | 10 |
| 4.1.2 <i>Dynamic Line Management (DLM)</i> | 11 |
| 4.2 SINGLE-ENDED, DUAL-ENDED AND METALLIC LINE TESTING | 11 |
| 4.3 VECTORING..... | 13 |
| 4.4 IMPULSE NOISE PROTECTION | 16 |
| 4.5 SEAMLESS RATE ADAPTATION (SRA) | 18 |
| 4.6 SOS | 19 |
| 4.7 APPLICATION LAYER TECHNIQUES | 20 |
| 4.7.1 <i>Application Layer FEC</i> | 20 |
| 4.7.2 <i>RTP/RTCP Retransmission as an Application Layer technique to improve IPTV QoS</i> 21 | |
| 5 CONCLUSION | 22 |
| 6 REFERENCES AND TERMINOLOGY..... | 23 |
| 6.1 REFERENCES | 23 |
| 6.2 ABBREVIATIONS | 24 |

List of Figures

Figure 1: QoS and QoE..... 8
Figure 2: Pixilation or Checkerboarding..... 9
Figure 3: Reference Fiber Fed DSL Network Access Architecture. 13
Figure 4: Example VDSL2 performance improvements in a 100 pair cable with vectoring. 15
Figure 5: Reference signals demonstrating impact of impulse noise. 16
Figure 6: Network architecture for retransmission 21

1 Executive Summary

DSL has provided for the delivery of broadband services since the mid-1990s. By the fourth quarter of 2010, the world had over 350 million DSL lines in service, accounting for over 65% of the total broadband access market. In such a competitive access environment, differentiation is fundamental to business and driving revenue. To that end, IPTV has been considered a technology with major potential for providing new and attractive services, and delivery of high quality IPTV content becomes a necessity for continued growth and viability of DSL access.

Most TV viewers have high expectations with respect to their Quality of Experience (QoE) for television services. This expectation translates into equally stringent requirements for Quality of Service (QoS) of the underlying delivery mechanisms. The viewer expects to have their required QoE and expects the underlying technology to be easy to use, stable, and flexible. In this context, it is critical to apply measures which drive copper access to provide the highest levels of line speed, signal quality and service stability.

IPTV over DSL must continue to enhance its capabilities in order to compete with TV services provided by terrestrial TV, hybrid fiber coaxial cable services, fiber to the home and satellite delivery of TV. This white paper outlines the issues raised by IPTV over DSL in terms of the users' experience, the technical requirements, and the tools both current and emerging that allow DSL to support IPTV services successfully to millions of viewers.

2 Introduction

IPTV over Digital Subscriber Lines (DSL) is a solution to delivering high quality services such as live and interactive television over a broadband connection. With hundreds of millions of DSL lines in service, maintaining and improving quality of the DSL broadband access to support stringent IPTV requirements is key in retaining customers and driving additional revenue services.



Quality drives user choices
„Why have you chosen us?“

- ✓ **digital picture & sound quality**
- ✓ **all-in-one solution**
- ✓ **promotional offer**



Source: European IPTV Service Provider
 Customer Survey

The impact of quality in IPTV is not only applicable for the installed base of DSL, as DSL penetration continues to grow and IPTV requirements become more stringent, IPTV over DSL solutions are met with increasing challenges:

- Increasing bandwidth demand as HDTV and 3DTV content become popular
- The number of televisions in the home is growing
- Customer expectations of service responsiveness and selection are growing

How can IPTV over DSL meet these expectations and challenges while simultaneously facing competitive TV services offered by cable and satellite technologies? The Broadband Forum's Technical Report TR-126 [1] addresses requirements for QoE and QoS for triple play (Voice, Video and High Speed Internet) services. MR-180 discusses several methods to address the Quality of Experience (QoE) challenges faced by a successful IPTV over DSL deployment within a TR-126 context.

3 Quality of Experience and Quality of Service challenges facing IPTV over DSL

In a customer survey at a European Service Provider with over 500 thousand IPTV users (the majority of them having broadband connection via DSL), quality was the decisive factor in users choosing their Service Provider. In particular issues of viewer control, data/image quality, service interruption/failures, security and privacy were the important quality criteria for the viewers.

The challenge for quality increases even more with deployment of interactive video applications, the advent of 3DTV, support of user-created content and the simple proliferation of multiple HDTV streams to the customer premise. In this context, user-QoE expectations translate into network-QoS requirements such as:

- System reliability: If there's a failure, how long does it take to recover?
- Signal noise and impairment: will the service stream be delivered free of defects to ensure high quality video?
- System capacity: Is there enough bandwidth to deliver the service to begin with?
- Bandwidth stability: Is the bandwidth stable enough to ensure the sustained delivery of high quality video?
- Transmission delay and variability: Is the video service responsive or is it affected by delay or jitter?

The QoS requirements above combine with the network operator's operational requirements to define the whole picture; do the benefits of improving QoS exceed the costs to the network operator? These significant operational issues include:

- Complexity of service installation
- Ability to diagnose and repair problems
- Availability of tools that monitor the network and report service status.

In order to effectively address IPTV quality issues, it is important to understand the source and cause of IPTV signal degradation. When distributing video over IP networks, visual artifacts and degradations can be experienced by end-users, as a result of QoS issues due to physical layer transmission impairments or IP transport issues. These degradations and impairments may be due to impulsive noise, cable quality, radio frequency interference, crosstalk and fluctuating noise. Further, these degradations can be exacerbated by the use of an incorrect cable type, or installation practice such as improper home wiring.

While certain degradations affecting the image or sound quality of IPTV can be caused by problems with the DSL physical access, others derive from the video and audio compression parameters chosen at the headend TV and other mechanisms in the other network elements that provide the end-to-end transport. Problems can include packet loss, link failure, or jitter. They can be introduced throughout the network or by the end-user devices; by the TV headend, routers, network engineering decisions and encoder settings. Often, these problems arise as a trade off between reliability of the IPTV stream and the bandwidth requirements of the service delivery network.

3.1 Bandwidth and the viewer experience

In the IPTV architecture, compressed video streams range from 1.5 Mbits/s (for SD flows) up to 20 Mbit/s, for HD or 3DTV streams. Common video compressing or encoding techniques are MPEG-2 and H.264. Both define MPEG frames that carry the video streams from the head-end TV all the way to the customer’s set top box.

The figure below summarizes the issues related to QoS and QoE that may be experienced when dealing with an IPTV-based network.

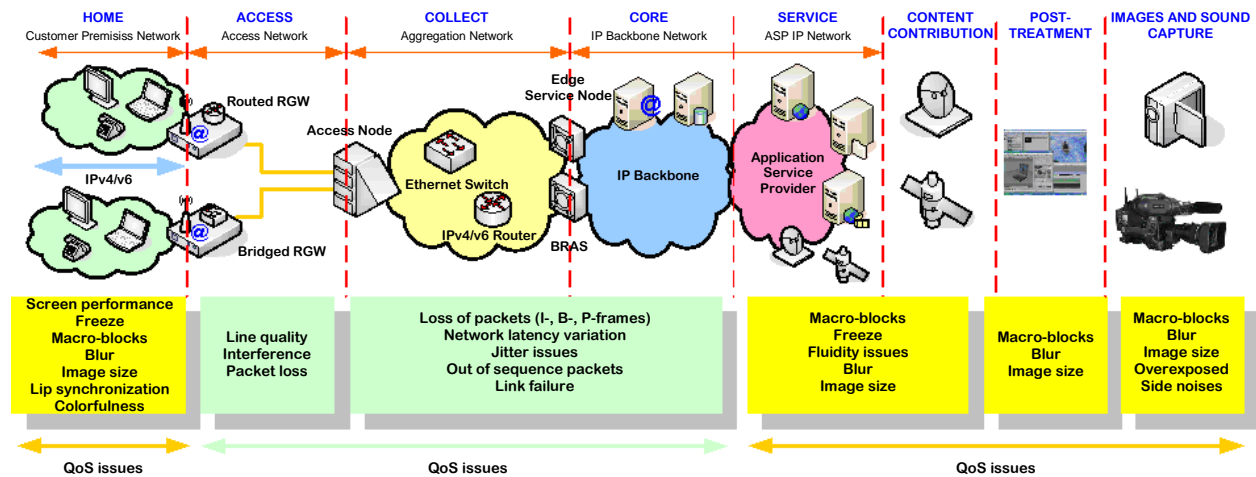

Figure 1: QoS and QoE

The most common signal degradation that may appear when delivering video traffic over an IP network is the macro blocking effect on the image also called “pixilation” or “checkerboarding” (Figure 2).



Figure 2: Pixilation or Checkerboarding

Video artefacts reduce QoE significantly and are caused by packet loss in the transport network. Depending on which type of encoded video data information that is lost, the effect can be of high or low impact. For instance, if an I-Frame, which carries the reference information of the digitalized image, is lost it might cause a significant freeze in the picture. The same impact is not caused by loss of other MPEG frame types, B-Frame and P-Frame, which are based on predicted and relational video data. In this way, quality concerns are divided between the capabilities of the MPEG compression and the network.

4 Meeting the Requirement of IPTV over DSL

Various degradations can occur on the DSL access link and in the rest of the end-to-end network that will have negative impact on video QoS/QoE. The sources of potential QoS degradation on IPTV over DSL networks are insufficient bandwidth, transmission errors on DSL Access, the quality of MPEG compression and issues in the end-to-end network from the IPTV server to the IPTV set top box. The sections that follow provide an overview of tools to address these issues:

- DSL line management tools related to Broadband Forum DSL Quality Management as defined in TR-198 [4], including DSM and DLM, enhance the performance of DSL services, while DSL line testing as defined in G.996.2 [13] assists in diagnosing problems with a DSL service.
- Recent enhancements to DSL transmission standards improve the performance of DSL services when they are affected by interfering noise. The techniques discussed are
 - active noise cancellation using Vectored DSL (G.993.5 [12]),
 - Physical Layer Retransmission to reduce the effects of impulse noise (G.998.4 [15]),
 - Seamless Rate Adaptation (SRA) that increases DSL robustness to changing line conditions. (ADLS2 [8], VDSL2 [11]),
 - VDSL2 ‘SOS’ technique which enables rapid recovery from temporarily degraded line conditions while avoiding service-interrupting DSL retrains. , (G.993.2 Amendment 3 [11])
- Application Layer error correction techniques such as Application Level Forward Error Correction (Application Level FEC) and Application Layer Retransmission reduce packet loss arising anywhere in the network, including as a result of DSL transmission errors.

4.1 DSL Quality Management (DQM)

DSL Quality Management is a term introduced in 2010 by the Broadband Forum in TR-188 [3], and TR-198 [4] covering various techniques that use DSL line performance, status, test and other data, as inputs to analysis and diagnosis functions. DQM techniques can lead to potential corrective actions whose aim is the amelioration of problems or improved performance. Generally speaking this is based on the following DQM loop:

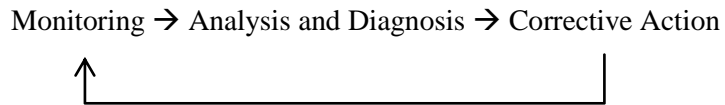

TR-198 provides an architecture that identifies the key functions of a DQM system and the external functions on which it depends and to which it delivers its output. Interfaces between the functional blocks and between the functional blocks and the external functions are identified. Existing standards that are relevant to these interfaces are indicated and the need for new standardized interfaces identified.

Dynamic Spectrum Management (DSM) and Dynamic Line Management (DLM), described below, are two specific DQM techniques of importance in IPTV over DSL management.

4.1.1 Dynamic Spectrum Management (DSM)

Dynamic Spectrum Management (DSM) systems are DSL management systems that utilize standardized DSL management parameters to perform two functions:

- Line optimization for achieving optimum rate/reach;
- Implementation of diagnostic algorithms to assist with fault detection and identification.

DSM systems optimize rate/reach using algorithms grouped into three ‘levels’:

- **DSM Level 1:** Selecting the best-allowed settings, including those parameters related to DSL line rate, margin, and impulse noise protection, for individual subscribers on a line-by-line basis, based on the observed noise and crosstalk for each line.
- **DSM Level 2:** Reducing the effects of crosstalk among all DSL lines in a cable by selecting DSL configurations that reduce coupling of energy between pairs in a cable. This decreases crosstalk between customers to a minimum and results in improved services for all customers served by a cable.
- **DSM Level 3:** Vectoring. In vectoring crosstalk between lines in the same cable is cancelled. A full explanation of this technique follows later in the document: see Section 4.3

DSM is described in the ATIS *Dynamic Spectrum Management (DSM) Technical Report* [5].

4.1.2 Dynamic Line Management (DLM)

Dynamic Line Management (DLM) is a widely used term for basic DSL profile optimization and diagnostic capabilities. In Broadband Forum Technical Reports TR-176 [2] and TR-198 [4] and the UK NICC *Dynamic Spectrum Management Report* [7] DLM is held synonymous with DSM Level 1. However, DLM systems may have diagnostic capabilities, and may also have some spectrum masking features that are similar to DSL Level 2.

4.2 Single-Ended, Dual-Ended and Metallic Line Testing

Line testing involves the measurement of electrical signals to determine the key parameters that characterize the loop and its noise environment. Its standardization provides a measurement process and allows for a unified reference model with distinctive functional blocks to measure the basic parameters while formally listing the key derived parameters and necessary interfaces for various possible application models in the field.

Single-Ended Line Testing (SELT), Dual-Ended Line Testing (DELT) and Metallic-Electrical Line Testing (MELT) are three complementary techniques that involve the measurement and interpretation of electrical signals to achieve any/all of the following goals:

- characterize the loop (length, bridged taps, etc.) and noise (crosstalk, RFI, etc.) environment
- detect and locate faults (bad contact, etc.) and other impairments (missing micro filter, etc.)
- determine the impact of physical parameters on data rates and service stability
- predict the feasibility of service upgrades
- recommend remedial actions such as hard technician intervention or soft adjustments to link profiles

SELT, DELT, and MELT are collectively defined in G.996.2. (DELT) [13] is further standardized in G.992.3 (ADSL2) [8], G.992.5 (ADSL2plus) [9], G.993.2 (VDSL2) [10] and G.997.1 [14].

SELT excites the line using the DSL transceiver and measures the echo signal to obtain key measurement parameters that enable expert interpretation software to generate a model of the line and diagnose for faults and degradations without any additional test hardware even when the far end device is not installed. The line model can also be used to predict the line capacity. SELT requires that the DSLAMs support the technology; very old equipment or equipment with limited feature set support may not. The information obtained by SELT about faults or degradations near

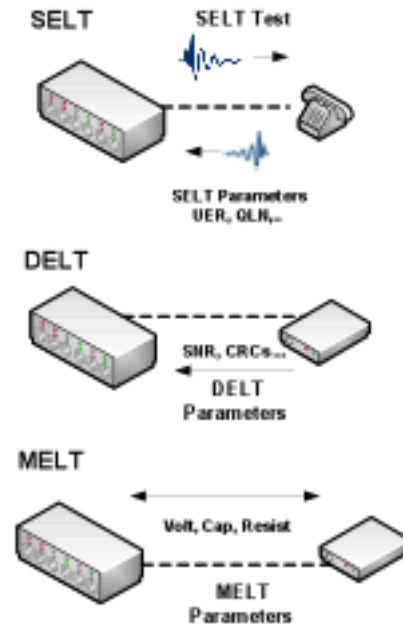

the far end of long loops may be limited by the effects of line attenuation on the measurement of the echo signal.

DELT requires both DSL transceiver ends to be connected and powered on, but it generates accurate loop quality parameters using the extensive measurement capabilities supported by the ADSL2, ADSL2plus and VDSL2 technologies. DELT is particularly suited to address the increasing fault identification issues faced by network providers while deploying quality sensitive services like IPTV.

MELT measurements utilize dedicated electrical test equipment that may be integrated into a DSL line card, integrated into a card that resides along with DSL line cards in a chassis, or resides in a separate chassis. Like SELT, measurements are performed from only one end of the line. MELT does not leverage the DSL transceivers, so this method implies in additional equipment costs. MELT measurements utilize a relatively narrow low-frequency range, so they are generally far less accurate when predicting broadband data rates and other broadband-frequency issues. However some MELT equipment can detect faults to ground and very precise pair balance measurements which are not detected by SELT or DELT.

4.3 Vectoring

VDSL2 is one of the leading DSL access technology choices for network operators targeting the deployment of triple-play services. This technology currently offers the capability of data transmission over a single pair of 100 Mbits/s or more downstream and 50 Mbits/s or more upstream, dependent upon configuration and loop environment. A major impairment, in addition to cable length, toward achieving the objective bit rates is the crosstalk injected into the cable by other VDSL2 signals; this added ‘self-crosstalk’ noise reduces the quality of the received signals. Vectoring is a signal processing technique implemented in the network equipment that cancels the self-crosstalk created by the VDSL2 transceivers so as to significantly improve the received signal quality enabling more customers in a serving area to receive higher quality IPTV services.

Figure 3 shows a network access diagram for deployment of vectored VDSL2. A fiber optic link provides a high speed connection from the central office to a location containing a vectoring capable VDSL2 DSLAM that contains the VDSL2 transceivers for serving homes with IPTV services over existing telephone lines. The DSLAM may be located at an intermediate point in the access plant, referred to as Fiber to the Node (FTTN), or it may be located inside a building serving multiple dwelling units, referred to as Fiber to the Building (FTTB).

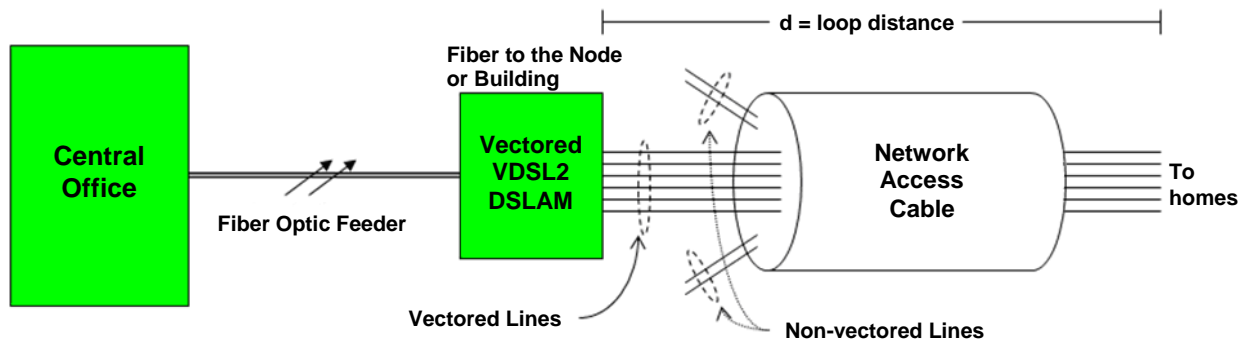

Figure 3: Reference Fiber Fed DSL Network Access Architecture.

In addition to the signal loss introduced by the cable, another disturber is crosstalk, i.e. both near-end crosstalk (NEXT) and far-end crosstalk (FEXT) injected by the VDSL2 signals. Far-end crosstalk (FEXT) is the dominant crosstalk disturber in a cable supporting only VDSL2 services; since the crosstalk is generated by similar VDSL2 signals, we refer to this as ‘self-crosstalk’ or ‘self-FEXT’. If this self-crosstalk can be removed from the cable, then the received signal is greatly improved and the target bit rates for a quality IPTV service may be offered to more customers..

G.993.5 [12] defines a protocol for implementation of self-FEXT crosstalk cancellation (Vectoring) with VDSL2 transceivers. The DSLAM contains one VDSL2 transceiver per line and all of the transceivers are collocated across one or more circuit boards in the DSLAM. The transmission of the VDSL2 data on each line is coordinated by the *vectoring engine* in the DSLAM. The levels of crosstalk coupling among the wire-pairs will vary from pair to pair and across the different frequencies. With appropriate exchange of signaling information between the VDSL2 transceivers in the DSLAM and the corresponding customer premises transceivers, the

vectoring engine learns and maintains knowledge of the crosstalk couplings between each of the wire pair combinations in the cable that may be used in the crosstalk cancellation process. The vectoring engine processes the data samples together with the crosstalk channel couplings to cancel the self-crosstalk introduced throughout the cable. The result is that the upstream and downstream received signals are of higher quality (i.e. higher signal-to-noise ratio) since the crosstalk noise has been removed, and more lines in the cable are enabled to carry the objective bit rate that would otherwise not be possible without crosstalk cancellation.

Note that the multi-pair cable may contain additional wire pairs that do not contain VDSL2 signals; these signals do not belong to the ‘vectoring group’ and so any crosstalk they introduce in the cable will not be cancelled. Additionally in the case of unbundling, VDSL2 lines from other network providers are considered as alien disturbers. These *non-vectoring* lines will introduce *alien* crosstalk, which will serve as the resulting background noise limiting the received signal quality after crosstalk cancellation.

Figure 4 shows an example of VDSL2 performance with vectoring when operating in a 100 pair 26 gauge cable environment containing 80 users. The results in Figure 4 are based on computer simulations using the crosstalk channel model developed by the North American DSL standards committee in ATIS-PP-0600024 (2009) [6]. The blue \times 's show the distribution of bit rates across the individual wire pairs at each of the given distances within the cable without vectoring. The rates with 99% worst case FEXT is represented with the symbol ∇ . The FEXT-free bit rates are shown with the symbol Δ . The distribution of bit rates with the cancelling of the 47 worst case disturbers is plotted in red using the symbol \circ .

When the top 47 disturbers are cancelled, the resulting bit rates (the red \circ 's) are very close to the FEXT free condition. If all the crosstalk is cancelled and there are no other alien disturbers in the cable, the achievable bit rates would be those of the FEXT-free case (the blue Δ 's).

In this deployment environment, Figure 4 shows that 100 Mbits/s service is possible over 26 AWG (0.4 mm) loops of 500 m (approximately 1500 ft). The computations show that 50 Mbits/s service is possible up to approximately 900 m (2700 ft), an increase of 3 times the reach (approximately 600 m or 1800 ft). With pair bonding and vectoring, 100 Mbits/s service may be extended up to 900 m (2700 ft).

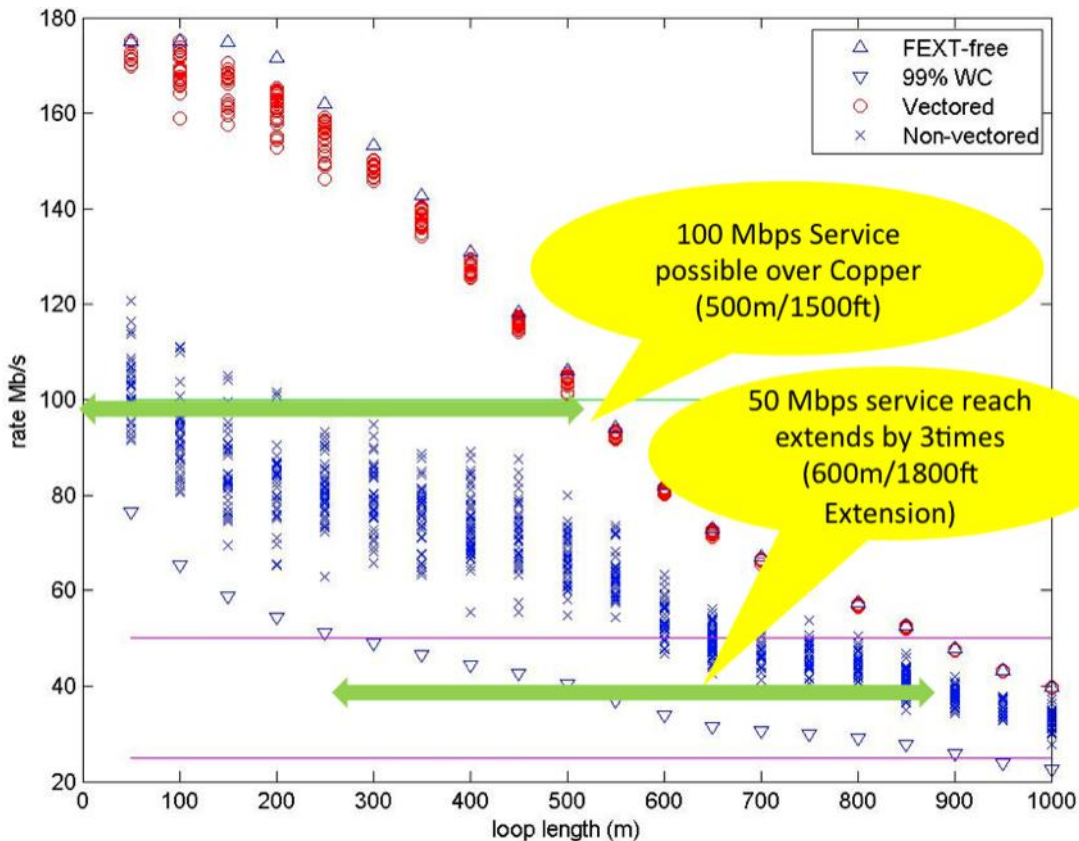

Figure 4: Example VDSL2 performance improvements in a 100 pair cable with vectoring.

Vectoring requires care in loop management as all loops in a binder that require vectoring to cancel crosstalk noise must be connected to the same vectoring DSLAM component (e.g. line card or other component that has the same vectoring hardware or software). Vectoring also raises issues where loop unbundling to support competitive provider is practiced as the lines in separate DSLAMs owned by different carriers will produce *alien* crosstalk into each other that cannot be cancelled using vectoring. DSM Level 3 techniques where a DSM Spectrum Management Center (SMC) determines which lines in a cable/binder benefit most from vectoring and instruct the DSLAM in configuring vectoring and in the priority of vectoring among the lines may enhance the capabilities of a vectored DSL system.

4.4 Impulse Noise Protection

A common impairment that may affect ADSL2/2plus and VDSL2 performance is impulse noise. Unlike crosstalk, impulse noise is *non-stationary* in that the noise events happen in momentary bursts followed by periods of relative quietness. In general the *bursty* nature of impulse noise does not (significantly) degrade the average quality of the received signal; however the instantaneous effect is a sudden burst of bit errors that may result in undesirable artifacts in the IPTV service if proper protection is not provided. The causes of impulse noise in the home are typically introduced through electromagnetic coupling events from the power lines running electrical appliances, like light dimmers, vacuum cleaners, hair dryers, etc. Since impulse noise events are likely to occur in the home environment, it is important that the DSL system providing IPTV service provides some level of impulse noise protection.

Figure 5 shows an example of how an impulse noise event affects the received ADSL2/2plus or VDSL2 signal. The top row of the figure represents the stream of Discrete Multitone (DMT) symbols transmitted on the subscriber line in the time domain, where each DMT symbol period (labeled T_s) is 250 μ s long. The DMT symbols carry the customer data and ADSL2/2plus or VDSL2 specific overhead data. The impact of an impulse noise event is not limited to the instant and to the duration of the actual impulse; instead an entire DMT symbol and possibly an adjacent symbol (see bottom row of the figure) may get affected, even if the impulse is shorter than the DMT symbol itself.

In addressing the mitigation of impulse noise, the amount of Impulse Noise Protection (INP) is defined as the number of sequential symbols for which the impulse noise protection method can protect.

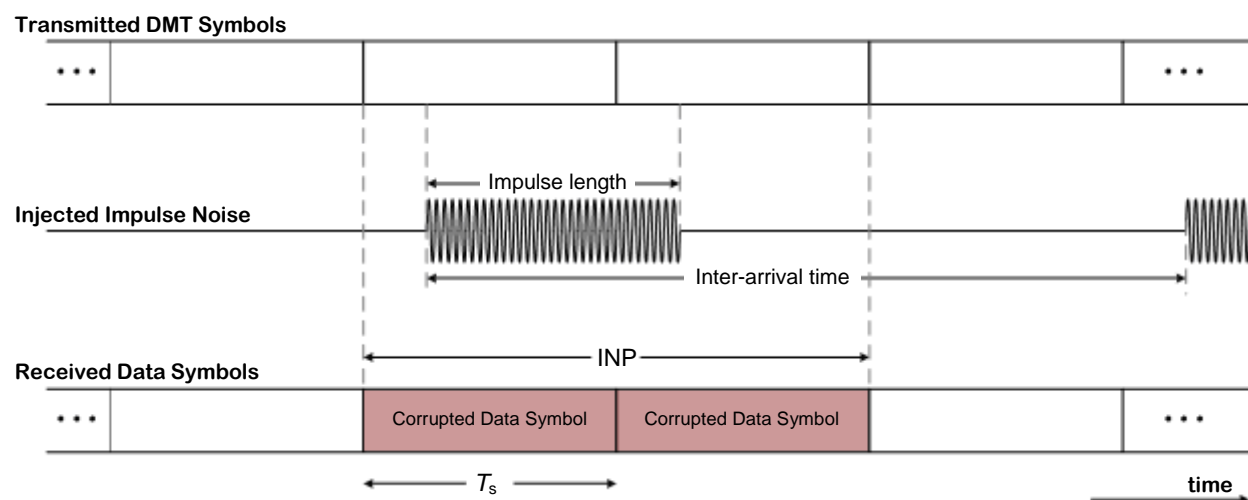

Figure 5: Reference signals demonstrating impact of impulse noise.

Impulse noise events exhibit a wide spectrum of durations, amplitudes and inter-arrival times. Two broad categories of impulse noise events are referred to as REIN (Repetitive Electrical Impulse Noise) and SHINE (Single High-level Impulse Noise Event). REIN events are repetitive impulses that occur at twice the AC frequency, 120 Hz or 100 Hz depending up on the AC

frequency of the region. SHINE is a general name for isolated impulses that are not predictable in their inter-arrival times.

In VDSL2 and ADSL2/2plus, impulse noise may be mitigated using one of two methods: (1) Forward Error Correction (FEC) using Reed-Solomon (RS) coding with interleaving, or (2) Physical Layer retransmission.

When using FEC plus interleaving, the transmitted data is partitioned into a sequence of RS codewords, in which each codeword has a number, K , of data bytes and a smaller number, R of redundancy bytes which allow detection and correction of errors. The decoder is able to correct up to $R/2$ errored bytes in each codeword. Interleaving scrambles the order of code words in a way that is easily recovered at the receiver so that an impulse noise is less likely to produce errors in any particular code word. During initialization, the modem configures the RS codeword size and the appropriate interleave depth based on the operator setting of control parameters.

While the FEC plus interleaving provides an effective mechanism for impulse noise protection, the following characteristics can be noted. The interleaving that is required to ‘spread’ the bytes introduces additional delay into the data stream that may not be acceptable for delay sensitive services. Also, the protection against impulse noise requires a fixed redundancy per codeword. This redundancy is introduced regardless of the occurrence of impulse noise. However, a benefit to the fixed redundancy and resulting delay is that the data rate is free of jitter. The longer the maximum impulse length for which protection is required, the higher will be the resultant coding overhead. For long impulses under strict maximum delay requirements, the overhead could climb up to 50%, even if the worst-case impulse occurs infrequently. Impulse noise protection using FEC and interleaving is best suited for frequently occurring impulses of short to medium duration. REIN would be a good example of such an impulse noise environment.

Alternatively, physical layer retransmission may be used to mitigate impulse noise. With retransmission, data is transmitted in contiguous blocks. Whenever any block is detected as corrupted or missing, the block is retransmitted. Retransmission offers the advantage that the overhead for correcting errors due to impulse noise is only used when impulse noise actually occurs. In the absence of impulse noise, retransmission does not incur an overhead penalty and can operate at its full data rate. One drawback of retransmission is the inherent jitter in data rate. This means that the incoming data stream is interrupted whenever a block of data needs to be retransmitted. Also, the maximum data rate that can be achieved by the system depends on the size of transmit and receive buffers.

G.998.4 [15] defines improved impulse noise protection for VDSL2 and ADSL2/2plus systems based on retransmission. In G.998.4, the fundamental block element used for retransmission is termed the Data Transmission Unit (DTU), where each DTU contains an integer number of RS *codewords*. In the case of retransmission, the RS *codewords* are not interleaved prior to encapsulation in a DTU. Prior to being transmitted, each DTU is placed in a retransmission queue for potential retransmission at a later time.

To help control the retransmission operation, a Retransmission Request Channel (RRC) is supported in the opposite direction of transmission. The RRC transfers information regarding the

status of received DTUs and allows the transmitter to determine the DTUs that are acknowledged as correctly received and those that require retransmission.

Analogous to the procedure used for FEC plus interleaving, the parameters of the retransmission function are determined during initialization based on control parameters set by the operator. The configuration parameters are the following: SHINE impulse length required for protection, REIN impulse length required for protection, Frequency of the REIN impulses (100 or 120 Hz), Minimum and maximum allowed delay, Maximum overhead due to retransmissions of SHINE impulses, and the minimum and maximum data rates. Based on these constraints the receiver determines the various framing parameters to meet the impulse noise protection requirements.

G.998.4 is a relatively new ITU-T Recommendation, therefore legacy equipment may not support this particular tool for dealing with impulse noise while FEC is a capability found in all standards compliant DSLs. Additionally Retransmission and FEC usage is complementary in that FEC when properly configured in a system supporting retransmission prevents unnecessary retransmissions thus increasing throughput of the connection.

4.5 Seamless Rate Adaptation (SRA)

Changes in DSL line conditions (e.g. changes in crosstalk levels in a multi-pair binder or radio interference levels) can cause a DSL system to drop the connection. ADSL2/ADSL2plus [8] [9] and VDSL2 [10] address this problem by including the ability to seamlessly adapt the data rate on-line. This ability, called Seamless Rate Adaptation (SRA), enables a DSL system to change the data rate of the connection while in operation without any service interruption or bit errors. The modem simply detects changes in the channel conditions (for example, a local AM radio station turning off its transmitter for the evening) and adapts the data rate to the new channel condition transparently to the user.

SRA enables changes in the transmission data rate parameters without modifying parameters which would cause the modems to lose frame synchronization resulting in uncorrectable bit errors or system restart. SRA uses the sophisticated Online Reconfiguration (OLR) procedures of DSL systems to seamlessly change the data rate of the connection.

SRA enables the modem to adapt its rate to the changing channel conditions to keep the noise margin in a predefined range so that the requirements of stability and Bit Error Rate (BER) are met and interruption of services can be avoided. Although, SRA requires quite a long time to process its changes because the measurement of SNR takes time and each SRA operation modifies only up to 128 sub-carriers, it provides an automatic means of adaptation to slowly changing noise environments.

4.6 SOS

The SOS mode, defined in VDSL2 [10] [11], provides emergency Online Reconfiguration of the DSL link to adapt to conditions of sudden large increases in noise (or a sudden large degradation in Signal to Noise Ratio - SNR). The VDSL2 SOS mode ensures that a connection is maintained on the DSL link regardless of these suddenly degraded conditions and allows the application to maintain at least a minimal connection during a period of degradation. SOS mode thus can prevent a DSL retrain which allows a more graceful return to normal operation when the period of degradation has ended. SOS mode provides transparency to the higher layers by providing means for configuration parameter changes that introduce no transport errors, no latency changes, and no interruption of service. The goal of SOS is to avoid a full system retrain while maintaining the minimum required quality of service.

During showtime, the modems monitor the SNR to make sure the communication channel is running appropriately. When the measured SNR indicates a sudden noise increase, and SOS is being used, the receiver decides the bit-loading adjustment necessary to maintain reliable communication, and informs the far-end transmitter. With SOS a short and reliable message is used to request the new bit-loading. In the new SOS bit-loading all the used tones are divided into a small number of tone groups during initialization and the bit-loading reduction in each tone group is constant when SOS is applied. This simple method ensures that a connection is maintained during times of highly degraded signal. The message channel to send the SOS request from the receiver to the far-end transmitter is the highly reliable Robust Overhead Channel (ROC), defined for SOS. The far-end transmitter receives the SOS request and sends back a special reliable trigger signal to synchronize the bit-loading adjustment.

The key benefit of SOS is to avoid retrains when the noise suddenly increases. Each retrain takes about 60 seconds to recover the physical link. Due to the physical link disruption, the higher layers may be disrupted as well and they may take quite a long time to recover. Such disruptions are undesirable for QoE of IPTV and many other services.

After a successful SOS procedure, if the noise condition improves, SRA can be used to gradually increase the data rate; if the noise condition reaches the same level as right before the severely degraded condition that led to the SOS procedure, SRA can be used to fully recover the data rate before the SOS procedure. Therefore, compared with a full retrain, the combination of SOS and SRA can survive a sudden noise event without interruption of service. SOS is supported only in VDSL2 and as a recent enhancement to the Recommendation certain legacy equipment may not support the feature.

4.7 Application Layer Techniques

Application Layer techniques include Application Layer Forward Error Correction (FEC) where some redundant information is sent end-to-end in order to re-build missing information at the receiver. Several types of Application Layer FEC can be considered each with a different correction efficiency, overhead and complexity. Another approach is based on Retransmission mechanisms: when one or several packets are lost, the set-top-box sends a message to a retransmission server which is able to retransmit requested audio/video packets.

4.7.1 Application Layer FEC

The generic principle of a FEC mechanism at the Application Layer, like that at the DSL layer, is to add redundant information to the information to be sent in order to re-build missing information at the receiver side, using the redundant information.

The main advantages and appropriate usage of Application Layer FEC are:

- This type of FEC can be sized for typical ADSL loss profiles.
- The FEC is equally well applicable on unicast or multicast streams and doesn't need any upstream capacity.
- In terms of scalability, the required bandwidth for FEC only depends on the number of protected channels and can be considered constant according to number of customers and loss profiles.
- Impacts on architecture are rather low: for a end-to-end protection, they are mainly located at the headends where FEC inserters are to be added and at the set-top-boxes where FEC decoders are to be implemented.

The implementation and deployment issues for this method are:

- The number and size of the errors to be corrected is limited depending upon the acceptable level of overhead
- Zapping time increase: to improve efficiency of the correction, column FEC packets are transmitted interleaved with media packets of the following matrix. As a consequence, the FEC decoding function has to wait for two matrixes before starting the process which contributes to increase of the zapping time. However, although this contributes to an increased zapping time, the resulting quality of experience is largely improved. Although zapping time is increased the resulting quality of experience is largely improved.
- Headends have to be re-designed to integrate FEC encoders and back-up features in order to ensure that media streams are always sent even in the case of FEC encoder failure or overload.
- Dedicated bandwidth for the FEC is needed on the access link.

4.7.2 RTP/RTCP Retransmission as an Application Layer technique to improve IPTV QoS

When a receiver detects the loss of packets, the principle of the retransmission is to ask the MPEG server for the retransmission of missing packets. RFC 3550 [17], RFC 4585 [18] and RFC 4588 [19] are used in the context of IPTV as they provide protocols and methodology to specify a method for retransmission-based TV services delivered over the RTP protocol.

The characteristics of architectures of multicast TV (single source, very large multicast group and no interaction between receivers) require adapting the usual architecture for support of application level retransmission. For that purpose RFC 5760 [20] presents an end-to-end architecture where multicast participants send out RTCP data using unicast feedback. The method used in RFC 5760 has a number of advantages. In this method a unicast feedback is only sent out by the receiver only in case of loss detection. This avoids the retransmission servers being exposed to a constant storm of RTCP feedback. The retransmitted data are sent unicast in most of the cases avoiding unnecessary transmission of data to users unaffected by a packet loss. This method also allows the retransmission source to be from servers distributed in the network which improves scalability. This architecture is depicted in Figure 6.

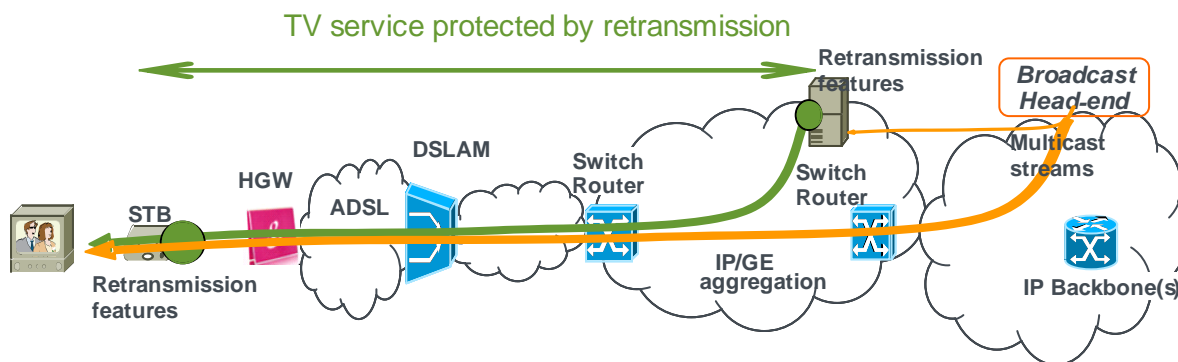

Figure 6: Network architecture for retransmission

Retransmission using RFC 5760 is able to correct any packet loss ratio (PLR) within a specified protection time provided that the required network bandwidth is available and retransmission time is reasonably lower than the protection time. Bandwidth is used effectively in that additional bandwidth is needed in both the backbone network and the DSL access only in case of retransmission of packets so typically average retransmission overhead is approximately the Packet Loss Ratio (PLR).

Application Level Retransmission however does require network resources and careful engineering. Retransmission requires servers located in throughout the network and bidirectional unicast communications between the STB and these servers. These servers must be configured to support the expected worst-case scenarios. Addition backbone network bandwidth, which grows with the number of customers supported, is required to transmit both the retransmission requests and the retransmitted data and the networks must be configured to support the protocols. STB must support the retransmission protocol software and the necessary buffer space.

Properly engineered Application Layer retransmission can provide a good trade-off between correction efficiency and network resource consumption since extra bandwidth is only used in case of retransmission. Impact on access bandwidth will be limited as the retransmission bandwidth can reuse a best effort service's bandwidth.

The use of retransmission mechanisms requires the use of servers which must to be integrated in the network according to the forecasted load resulting from loss profiles of customers.

5 Conclusion

Various degradations can occur on the DSL access link and the rest of the end-to-end network that may have negative impact on video QoS/QoE. Several correction or mitigation methods are available:

DSL Quality Management (DQM) techniques.

Active noise cancelation using Vectored DSL.

Physical Layer Retransmission to reduce the effects of impulse noise.

Seamless Rate Adaptation (SRA) enhancements that increase DSL robustness to changing line conditions.

DSL 'SOS' techniques which enable rapid recovery from temporarily degraded line conditions while avoiding service interrupting DSL retrains.

Application Layer tools such as Application Layer FEC and retransmission.

All of the above techniques either attempt to correct or mitigate the effects of errors when they occur or minimize the chances of an error occurring. These techniques can also be used to increase the deployable footprint by bringing in those customers whose lines are not of sufficient quality without the above techniques to support an IPTV service. They are all valid techniques for improving quality in IPTV deployments. Deciding which particular techniques to use will be determined by the technology and capability of the network. Use of these techniques will improve the quality of the IPTV data transmission, the Quality of Service, and therefore the viewer's Quality of Experience. An excellent viewer experience is the essence of a successful IPTV deployment.

6 References and Terminology

6.1 References

The following references are of relevance to this Marketing Report. At the time of publication, the editions indicated were valid. All references are subject to revision; users of this Marketing Report are therefore encouraged to investigate the possibility of applying the most recent edition of the references listed below.

A list of currently valid Broadband Forum Technical and Marketing Reports is published at www.broadband-forum.org.

| Document | Title | Source | Year |
|--------------------------|--|-----------------|------|
| [1] TR-126 | <i>Triple-play Services Quality of Experience (QoE) Requirements</i> | Broadband Forum | 2006 |
| [2] TR-176 | <i>ADSL2Plus Configuration Guidelines for IPTV</i> | Broadband Forum | 2008 |
| [3] TR-188 | <i>DSL Quality Suite</i> | Broadband Forum | 2010 |
| [4] TR-198 | <i>DQS: DQM systems functional architecture and requirements</i> | Broadband Forum | 2010 |
| [5] ATIS-0600007 | <i>Dynamic Spectrum Management Technical Report</i> | ATIS | 2007 |
| [6] ATIS-PP-0600024 | <i>Multiple-Input Multiple-Output Crosstalk Channel Model.</i> | ATIS | 2009 |
| [7] NICC ND-1513 | <i>Report on Dynamic Spectrum Management (DSM) Methods in the UK. Access Network.</i> | NICC | 2010 |
| [8] G.992.3 | <i>Asymmetric digital subscriber line transceivers 2 (ADSL2)</i> | ITU-T | 2009 |
| [9] G.992.5 | <i>Asymmetric digital subscriber line (ADSL) transceivers – Extended bandwidth ADSL2 (ADSL2plus)</i> | ITU-T | 2009 |
| [10] G.993.2 | <i>Very-high-speed Digital Subscriber Line Transceivers 2 (VDSL2)</i> | ITU-T | 2006 |
| [11] G.993.2 Amendment 3 | <i>Very high speed digital subscriber line transceivers 2 (VDSL2)</i> | ITU-T | 2008 |
| [12] G.993.5 | <i>Self-FEXT Cancellation (Vectoring) for use with VDSL2 transceivers</i> | ITU-T | 1998 |

| | | | |
|---------------------------------------|---|----------------|------|
| [13] G.996.2 | <i>Single-ended line testing for digital subscriber lines (DSL)</i> | ITU-T | 2009 |
| [14] G.997.1 | <i>Physical layer management for Digital Subscriber Line (DSL) transceivers</i> | ITU-T | 2003 |
| [15] G.998.4 | <i>Improved Impulse Noise Protection (INP) for DSL Transceivers</i> | ITU-T | 2010 |
| [16] <u>Pro-MPEG Code of Practice</u> | <i>Code of Practice #4</i> | Pro-MPEG Forum | 2004 |
| [17] RFC 3550 | <i>RTP: a Transport Protocol for Real-Time Application</i> | IETF | |
| [18] RFC 4585 | <i>Extended RTP Profile for Real-time Transport Control Protocol (RTCP)-Based Feedback (RTP/AVPF)</i> | IETF | |
| [19] RFC 4588 | <i>RTP Retransmission Payload Format</i> | IETF | |
| [20] RFC 5760 | <i>RTCP Extensions for Single-Source Multicast Sessions with Unicast Feedback</i> | IETF | |

6.2 Abbreviations

This Marketing Report uses the following abbreviations:

| | |
|-------|--|
| 3DTV | Three Dimensional TV |
| ADSL | Asymmetric Digital Subscriber Line |
| ADSL2 | Asymmetric Digital Subscriber Line version 2 |
| DELT | Dual Ended Line Testing |
| DLM | DSL Line Management |
| DMT | Discrete Multitone |
| DQM | DSL Quality Management |
| DSL | Digital Subscriber Lines |
| DSLAM | Digital Subscriber Line Access Multiplexer |
| DSM | DSL Spectrum Management |
| DTU | Date Transmission Unit |
| FEC | Forward Error Correction |
| FEXT | Far End Cross Talk |
| FTTB | Fiber to the Building |
| FTTN | Fiber to the Node |
| FTTP | Fiber to the Premises |
| HD | High Definition |
| HDTV | High Definition TV |
| HSI | High Speed Internet |

| | |
|-------|---|
| IAT | Inter-arrival Time |
| INP | Impulse Noise Presentation |
| IP | Internet Protocol |
| IPTV | Television over Internet Protocol |
| MELT | Metallic Line Testing |
| MPEG | Motion Picture Expert's Group |
| NEXT | Near End Cross Talk |
| OLR | Online Reconfiguration |
| PMD | Physical Media Dependent |
| QLN | Quiet Line Noise |
| QoE | Quality of Experience |
| QoS | Quality of Service |
| ROC | Robust Overhead Channel |
| RRC | Retransmission Request Channel |
| RS | Read-Solomon |
| SD | Standard Definition |
| SDTV | Standard Definition Television |
| SELT | Single Ended Line Testing |
| SLU | Sub-loop Unbundling |
| SMC | Spectrum Management Center |
| SNR | Signal to Noise Ratio |
| SOS | A VDSL2 technique to avoid DSL retrains in rapidly degrading noise conditions. SOS is not an acronym. |
| SRA | Seamless Rate Adaptation |
| STB | Set Top Box |
| UER | Uncorrected Error |
| VDSL2 | Very High Speed Digital Subscriber Lines – Issue 2 |
| VoD | Video on Demand |
| xDSL | DSL in general (that is ADSL, ADLS2, ADSL2plus or VDSL2) |

Notice

The Broadband Forum is a non-profit corporation organized to create guidelines for broadband network system development and deployment. This Broadband Forum Marketing Report has been approved by members of the Forum. This Broadband Forum Marketing Report is not binding on the Broadband Forum, any of its members, or any developer or service provider. This Broadband Forum Marketing Report is subject to change, but only with approval of members of the Forum. This Marketing Report is copyrighted by the Broadband Forum, and all rights are reserved. Portions of this Marketing Report may be copyrighted by Broadband Forum members.

This Broadband Forum Marketing Report is provided AS IS, WITH ALL FAULTS. ANY PERSON HOLDING A COPYRIGHT IN THIS BROADBAND FORUM MARKETING REPORT, OR ANY PORTION THEREOF, DISCLAIMS TO THE FULLEST EXTENT PERMITTED BY LAW ANY REPRESENTATION OR WARRANTY, EXPRESS OR IMPLIED, INCLUDING, BUT NOT LIMITED TO, ANY WARRANTY:

- (A) OF ACCURACY, COMPLETENESS, MERCHANTABILITY, FITNESS FOR A PARTICULAR PURPOSE, NON-INFRINGEMENT, OR TITLE;
- (B) THAT THE CONTENTS OF THIS BROADBAND FORUM MARKETING REPORT ARE SUITABLE FOR ANY PURPOSE, EVEN IF THAT PURPOSE IS KNOWN TO THE COPYRIGHT HOLDER;
- (C) THAT THE IMPLEMENTATION OF THE CONTENTS OF THE MARKETING REPORT WILL NOT INFRINGE ANY THIRD PARTY PATENTS, COPYRIGHTS, TRADEMARKS OR OTHER RIGHTS.

By using this Broadband Forum Marketing Report, users acknowledge that implementation may require licenses to patents. The Broadband Forum encourages but does not require its members to identify such patents. For a list of declarations made by Broadband Forum member companies, please see <http://www.broadband-forum.org>. No assurance is given that licenses to patents necessary to implement this Marketing Report will be available for license at all or on reasonable and non-discriminatory terms.

ANY PERSON HOLDING A COPYRIGHT IN THIS BROADBAND FORUM MARKETING REPORT, OR ANY PORTION THEREOF, DISCLAIMS TO THE FULLEST EXTENT PERMITTED BY LAW (A) ANY LIABILITY (INCLUDING DIRECT, INDIRECT, SPECIAL, OR CONSEQUENTIAL DAMAGES UNDER ANY LEGAL THEORY) ARISING FROM OR RELATED TO THE USE OF OR RELIANCE UPON THIS MARKETING REPORT; AND (B) ANY OBLIGATION TO UPDATE OR CORRECT THIS MARKETING REPORT.

Broadband Forum Marketing Reports may be copied, downloaded, stored on a server or otherwise re-distributed in their entirety only, and may not be modified without the advance written permission of the Broadband Forum.

The text of this notice must be included in all copies of this Broadband Forum Marketing Report.

End of Broadband Forum Marketing Report MR-180